

Your success counts

Flowcomputer with temperature and pressure compensation for corrected gas volume



Modbus



Application examples: Salty Off-Shore conditions



Extreme cold weather at polar regions



Hot and sandy deserts

The E-Series provides unequalled safety and ease of use, opening the cover is history. The through-glass keypad enables operability without interruptions. The E-Series saves time, money and hassle and delivers user-friendliness in the toughest conditions.

Advantages

- Save time and gain flexibility with the easy-to-operate through glass keypad: no need to remove the front cover or to arrange a work permit.
- Intuitive "Know one, know them all!" configuration menu, saving time, cost and aggravation.
- Cost saving with an easy to install, spacious chamber, plug and play connectors and 1" NPT thread for flow meter mounting.
- Durable high grade stainless steel 316L Ex d enclosure for extremely salty atmospheres (offshore).

Features

- Explosion proof according ATEX, IECEx, FM and CSA c-us.
- Displays flow rate, total, acc. total, daily total, previous day total, actual line press. & temp., measuring units and a speedometer.
- Bright LED backlight.
- Easy K-factor configuration for volumetric or mass.
- Ability to process all types of signals: Sine wave (coil), NAMUR, NPN/PNP pulse, Reed-switch, Active pulse signals.
- Temperature: 2, 3 or 4-wire PT100 or (0)4 - 20mA input.
- Pressure: (0)4 - 20mA signal input.
- Scaled pulse output according to compensate acc. total and input retransmission.
- Loop powered 4-20mA output acc. compensated flow rate.
- Modbus RS232 / RS485 or USB communication.
- Power requirements: Loop powered, battery or 9 - 27V DC.
- Sensor supply: 8.2 / 12 / 24V DC.
- Auto backup of settings and running totals.
- Easy configurable via PC with free downloadable software.

Introduction

The robust E126-EG is designed with a focus on your safety. It's beyond fulfilling the rules for hazardous area approvals, because the environment is often much tougher than explosion proof requirements demand. Experiencing flaws in your processes due to rain, snow, salty atmospheres (offshore) or early wear? The E126 delivers accurate measurement while withstanding the harshest conditions. The F126-EG measures the actual flow, temperature and pressure and converts it with an ideal gas formula to gas volume at reference conditions (e.g. 0°C/1.013Bar or 14.7PSI /60°F). The reference conditions can be configured in the settings. A compressibility factor can be set to approach a real gas behaviour.

Configuration

The E-Series uses the highly appreciated configuration structure of our F-, D- and N-Series product lines. Each setting is clearly indicated with an alphanumeric description, which avoids confusing abbreviations. Once familiar with one E-series product, you will be able to program all models in all series without a manual. For example: an (intrinsically safe) F126 is almost identical to an explosion proof E126 with the same three buttons: Know one, know them all!

Operation

Operation is done via the optical, easy-to-operate, through glass keypad without having to remove the front cover. These optical keys can be disabled. For easy handheld configuration there are three mechanical push buttons on the bottom side of the display collar when the cover is removed. All settings are accessed via a simple operator menu that can be passcode protected.



Display

The unique LCD display provides multiple flow data at a glance. The main information is displayed with 7 digits (12mm, 0.47") to show total, flow rate, temperature and pressure. The display has 11 digits (7mm, 0.28"), which can be set to show flow rate and accumulated total. Current day total (daily total) and previous day total, both non resettable are available as well. The last 15 historical day totals are stored and can be displayed. On-screen engineering units are easily configured from a comprehensive selection, while different units for flow rate and total can be displayed simultaneously. The speedometer offers a quick impression of the corrected flow rate. For good readings in full sunlight and darkness, the E126 is provided with a bright backlight. When battery powered the backlight is only operational after a keypad touch, to save battery life.

Hazardous areas

The E-Series has been certified according ATEX, IECEx, FM and CSA c-us with an ambient temperature of -40°C to +70°C (-40°F to +158°F). For stainless steel 40°C to +67°C (-40°F to +153°F).

- The ATEX markings for gas and dust applications are:
 - Ex II 2 G Ex db IIC T6 Gb.**
 - Ex II 2 D Ex tb IIIC T85°C Db.**
- The IECEx markings for gas and dust applications are:
 - Ex db IIC T6 Gb.**
 - Ex tb IIIC T85°C Db.**
- The FM and CSA c-us markings are:
 - XP (Explosion-proof): Class I, Division 1, Groups A, B, C, D.**
 - DIP (Dust-Ignition-proof): Class II/III, Div. 1, Groups E, F & G.**
 - Class I, Zone 1, AEx d IIC T6 Gb, Zone 21, AEx tb IIIC T85°C Db.**



All info at a glance



Easy to install



Easy to program



Know one know them all!



Reliable



User-friendly

Analog output

The corrected gas flow rate is transmitted with the galvanically isolated 4 - 20mA output signal. The E126 can even be loop powered via the isolated loop-current.

Pulse outputs

A scaled pulse output is available according the corrected accumulated total. The unscaled pulse output retransmits the incoming pulse signal. The pulse length is user defined from 1msec up to 10 seconds. The output can be a passive NPN signal or a mechanical relay output.

Power requirements

Several power inputs are available to power the E126 and sensor. As standard, the E126 can be loop powered via the isolated, two-wire, analog output. The battery powered version with a long life lithium battery and the basic 9 - 27V DC can power the E126 including the backlight, but don't offer a real sensor supply. A real sensor supply of 8.2, 12 or 24V is optional available with type PD.

Communication

Processed data can be read, total can be cleared and settings can be read and modified through the Modbus link (RS232 / RS485) or the local USB communication which is located at the side entry plug. Under safe conditions, the plug can be removed for easy configuration or data log extraction with a PC or laptop.

Enclosures

Two versions of our IP66/IP67, NEMA Type4X/7/9 explosion proof enclosures are available: a solid die cast aluminum or a high grade stainless steel 316L enclosure resistant to extremely salty atmospheres (offshore). The aluminum enclosure has an industrial two component coating and is better suitable for outdoor and chemical plant applications than powder coated alternatives. A major advantage for the installation engineer is the spacious mid-chamber for the cable entry in combination with the plug-and-play connectors. Especially for straight flow meter mounting a 1" NPT connection is available (see page 5 for available NPT and Metric threads sizes).

Remote configuration

Even more user-friendly is the remote configuration via a PC using the free downloadable E-Series Configuration Software. Depending on your product, just connect the E-Series to your PC with the special Configuration Cable (ACE02) or use the Modbus or USB communication cables (ACE01/06/07).

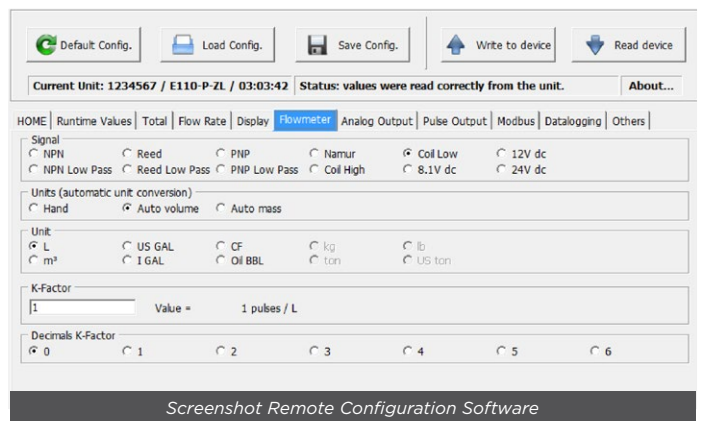

Overview application E126-EG

Flow measurement in applications where nett gas flow calculation at base conditions is desired. The E126 offers you a flowcomputer designed to be used in rough and tough applications, beyond being just explosion proof. Its sturdy design and ease of use are unequaled by any other explosion proof flowcomputer in the market! The E-Series is always your first and safest choice in explosion proof applications. For intrinsically safe applications we offer our field mount F-Series flowcomputers.

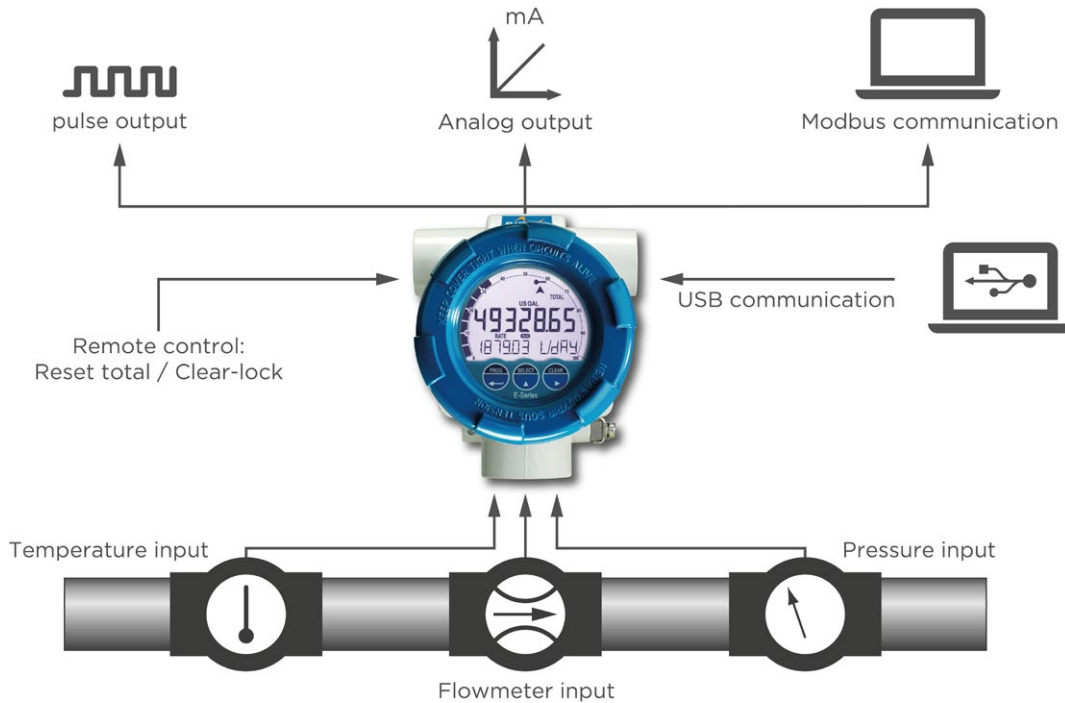

Signal input

The E126-EG accepts most pulse input signals for flow. The input signal type can be selected in the configuration menu without having to adjust any sensitive mechanical dip-switches or jumpers. For the temperature measurement, 2, 3 or 4-wire PT100 elements or sensors with a (0)4 - 20mA output signal can be used, just as for the pressure measurement.

Type of signal	Resistance	Low Pass filter (LP)	Max. frequency	Max. frequency Low Pass filter (LP)	Min. amplitude p-P	Remark
NPN	100kΩ pull-up	100kΩ pull-up	6kHz Threshold 1.2V	2.2kHz		Open collector
REED	1MΩ pull-up	1MΩ pull-up	1.2kHz Threshold 1.2V	120Hz		
PNP	51KΩ pull-down	51KΩ pull-down	6kHz Threshold 1.2V	700Hz		
NAMUR	820Ω pull-down	-	4kHz	-		External power required
COIL LO	-	-		-	90mV _{pp}	Default sensitivity
COIL-HI					20mV _{pp}	Sensitive for interference!
COIL-HI (Type ZF)	-	-	-	-	10mV _{pp}	
COIL-HI (Type ZG)					5mV _{pp}	
ACTIVE 8.2V DC	3K9Ω		10kHz Threshold 4V			External power required
ACTIVE 24V DC	3KΩ		10kHz Threshold 12V			External power required

Dimensions enclosures

Aluminum & Stainless Steel 316L enclosure

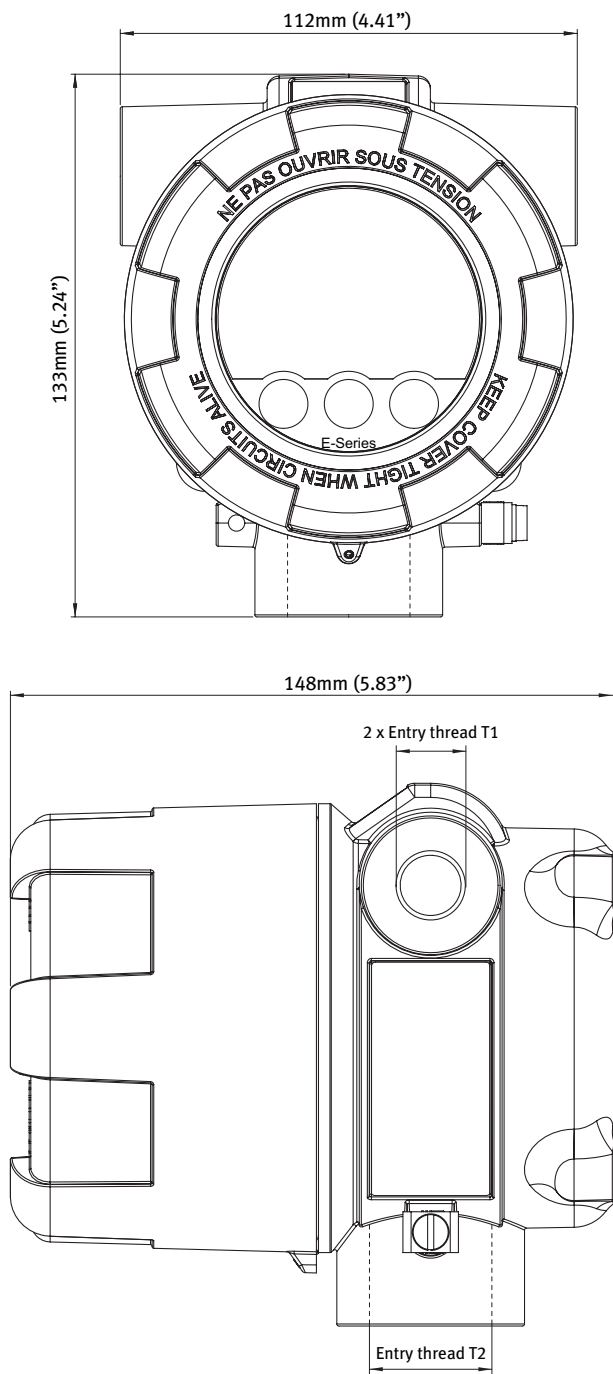

Enclosure types

Type HA_	Aluminum Ex d enclosure.
Weight	1300 gr.
Type HS_	Stainless steel 316L Ex d enclosure.
Weight	3600 gr.

Enclosure drillings

Type H_A	T1: 2 x 3/4"NPT / T2: 1 x 1"NPT
Type H_B	T1: 2 x 3/4"NPT / T2: 1 x 3/4"NPT
Type H_C	T1: 2 x 1/2"NPT / T2: 1 x 1"NPT
Type H_D	T1: 2 x 1/2"NPT / T2: 1 x 3/4"NPT
Type H_G	T1: 2 x M20 / T2: 1 x M25
Type H_H	T1: 2 x M25 / T2: 1x M25

Terminal connections

Main Electronics Module

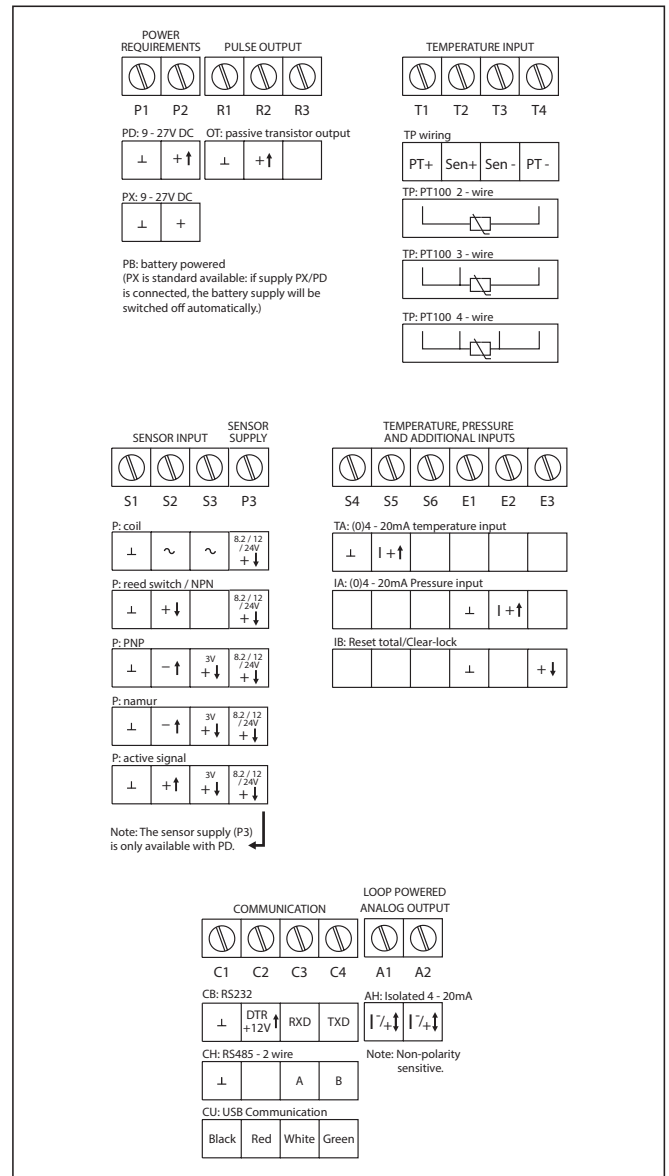

Supply Module

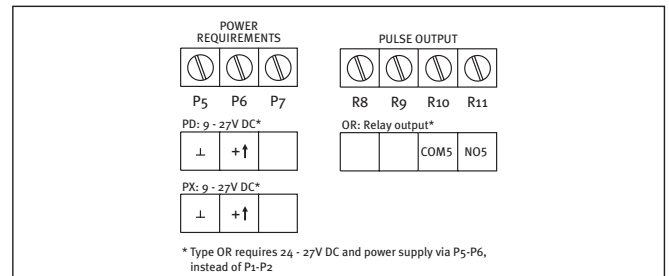

E126-P-AH-CB-EG-IA-IB-OR-PD-TA-XD-ZB

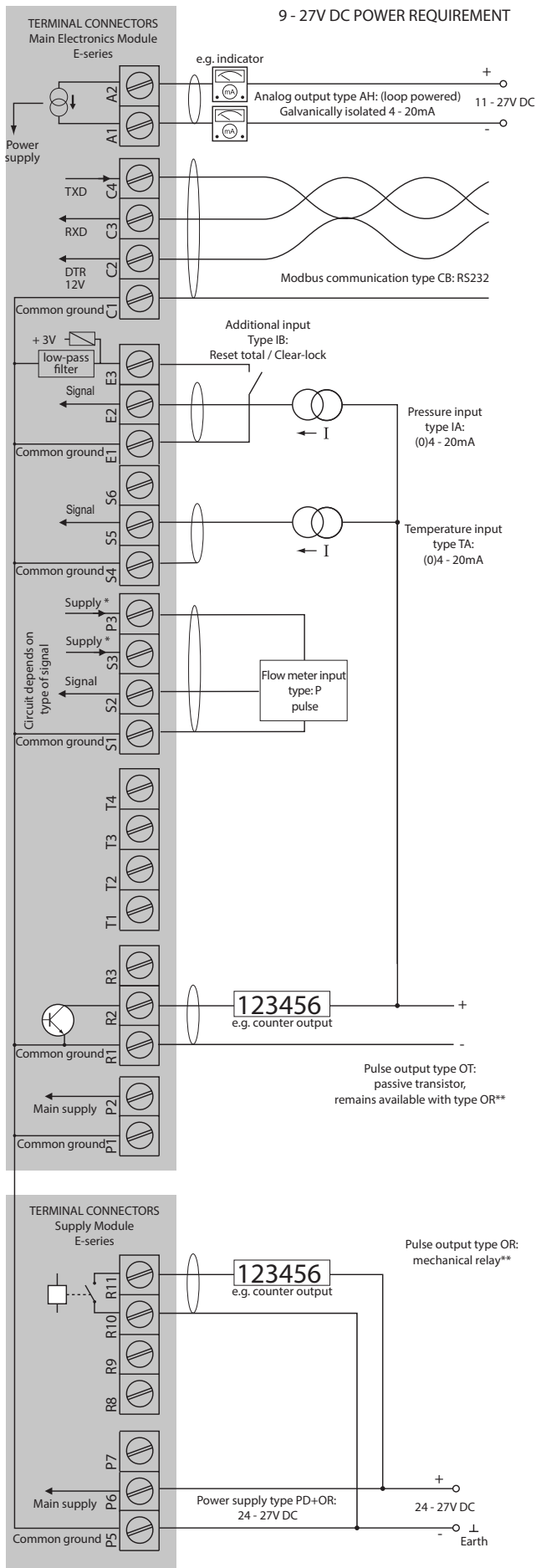

E126-P-AH-CH-EG-IA-IB-OT-PX-TP-XD-ZB

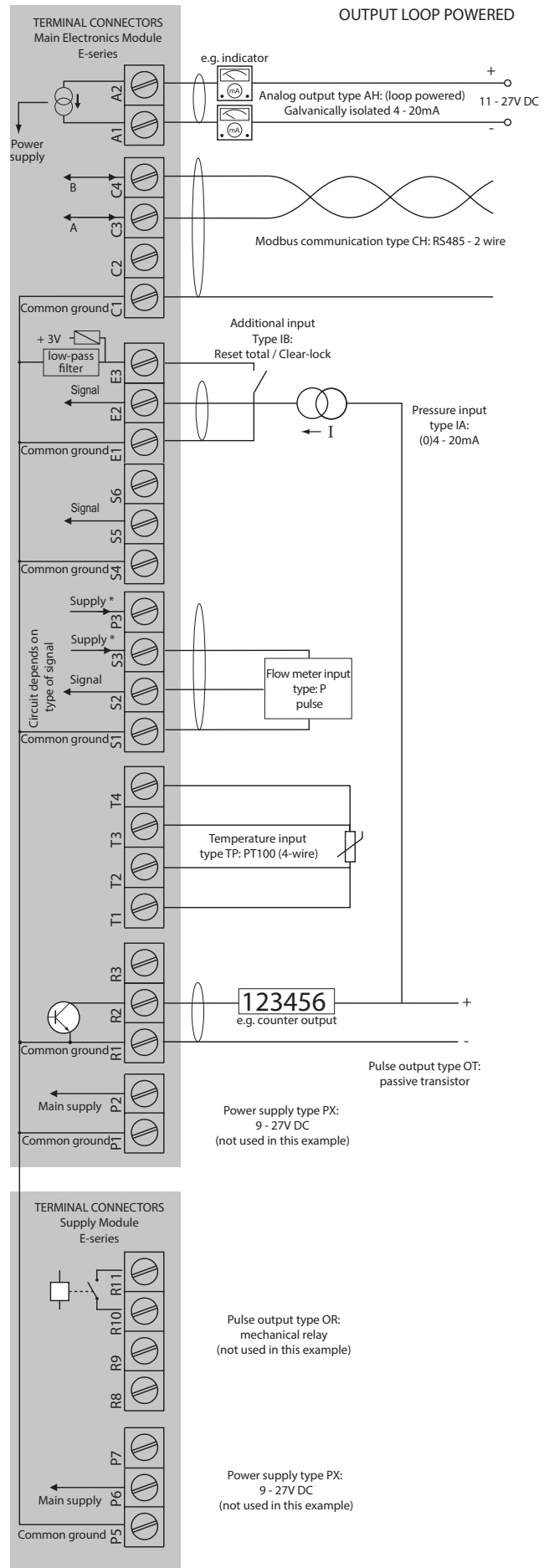

Display

Type	High intensity transfective numeric and alphanumeric LCD, UV-resistant, with bright backlight. Intensity can be adjusted via the keypad.
Note	When battery powered, the backlight is only operational after a keypad touch, to extend battery lifetime.
Dimensions	Ø 65 x 45mm (2.56" x 1.77").
Digits	Seven 12mm (0.47") and eleven 7mm (0.28") digits. Various symbols and measuring units.
Refresh rate	User definable: 8 times/sec. - 30 secs.
Speedometer	To indicate the actual flow rate the bargraph runs from 0 to 100% in 20 blocks, each block is 5%.

Operating temperature

Ambient HA_	-40°C to +70°C (-40°F to +158°F).
Ambient HS_	-40°C to +67°C (-40°F to +153°F).

Power requirements

Type PB	Long life Lithium battery - life-time depends upon settings and configuration - up to approx. 3 years.
Note PB	The battery can power the backlight for a short time after a keypad touch but cannot power the relay output (OR) or the real sensor supply (Terminal P3).
Type PD	9 - 27V DC. Consumption max. 4.5 Watt.
Type PX	9 - 27V DC. Consumption max. 3 Watt.
Type AH	Loop powered, analog output. 11 - 27V DC, Min. 3.5mA. Consumption max. 675mW (25mA @ 27VDC)
Note AH	The loop powered analog output cannot power the backlight, mechanical relay output (OR) or the real sensor supply (Terminal P3).

Sensor excitation

Type AH/PB/PX	Terminal S3: 3V DC for pulse signals and 1.2V DC for coil pick-up, I _{out} max. 100µA.
Note AH/PB/PX	This is not a real sensor supply. Only suitable for sensors with a very low power consumption like coils (sine wave) and reed-switches.
Type PD	Terminal P3: 8.2 / 12 / 24V DC 8.2V DC, I _{out} max. 20mA. 12V DC, I _{out} max. 30mA. 24V DC, I _{out} max. 75mA (this voltage varies depending on the input supply voltage)

Terminal connections

Type	Removable plug-in terminal strip. Wire max. 1.5mm ² and 2.5mm ² .
-------------	---

Data protection

Type	EEPROM backup of all settings. Backup of running totals every minute. Data retention at least 10 years.
Password	Configuration settings and clear total can be password protected.

Directives & Standards

EMC	Directive 2014/30/EU, FCC 47 CFR part 15.
Low voltage	Directive 2014/35/EU
RoHS	Directive 2011/65/EU
ATEX / IECEx	Directive 2014/34/EU, IEC 60079-0, IEC 60079-1, IEC 60079-31.
FM	Class 3600, 3615, 3616, 3810.
CSA	CSA 22.2 No. 25, No. 30, No. 61010-1-12.
UL	UL 61010-1.
IP & NEMA	EN 60529 & NEMA 250.

Hazardous area - Explosion proof

ATEX certification	Gas: II 2 G Ex db IIC T6 Gb. Dust: II 2 D Ex tb IIIC T85°C Db.
IECEX certification	Gas: Ex db IIC T6 Gb. Dust: Ex tb IIIC T85°C Db.
FM & CSA c-us certification	Class I, Div. 1, Grps A, B, C, D. Class II/III, Div. 1, Grps E, F, & G. Class I, Zone 1, AEx d IIC T6 Gb, Zone 21, AEx tb IIIC T85°C Db.

Enclosure - General

Window	Glass window.
Sealing	Silicone.
Control keys	Three infra-red keys with operation through the glass front window.
Rating	IP66, IP67 / NEMA Type4X / Type7 / Type9.
Dimensions	112 x 133 x 148mm (4.41" x 5.24" x 5.83") - W x H x D.
Mounting threads	4 x M6 at the backside of the enclosure.

Enclosure - Types

Type HA_	Aluminum Ex d enclosure.
Weight	1550 gr. (3.41 lbs).
Type HS_	Stainless steel 316L Ex d enclosure.
Weight	3600 gr. (9.65 lbs).

Enclosure - Drillings

Type H_A	Entry threads: 2 x 3/4"NPT / 1 x 1"NPT
Type H_B	Entry threads: 3 x 3/4"NPT
Type H_C	Entry threads: 2 x 1/2"NPT / 1 x 1"NPT
Type H_D	Entry threads: 2 x 1/2"NPT / 1 x 3/4"NPT
Type H_G	Entry threads: 2 x M20 / 1 x M25
Type H_H	Entry threads: 3 x M25

Signal inputs - Additional input

Function	Terminal input to reset total remotely or to lock the "clear total" button.
Type IB	Internally pulled-up switch contact - NPN.
Duration	Minimum pulse duration 100msec.

Signal inputs - Flowmeter

Type P	Coil / sine wave (HI: 20mVpp or LO: 90mVpp - sensitivity selectable), NPN/PNP, reed switch, Namur, active pulse signals 8 or 24V DC.
Frequency	Minimum 0Hz - maximum 10kHz for total and flow rate. Maximum frequency depends on signal type and internal low-pass filter. E.g. reed switch with low-pass filter: max. frequency 120Hz.
K-Factor	0.000010 - 9,999,999 with variable decimal position.
Low-pass filter	Available for all pulse signals.
Option ZF	coil sensitivity 10mVpp.
Option ZG	coil sensitivity 5mVpp.

Signal inputs - Temperature

Type TA	(0)4 - 20mA. Analog input signal can be scaled to any desired range within 0 - 20mA.
Accuracy	15 bit. Error 0.01% @ 20°C (Typical 35ppm/°C).
Span	0.00000 / 999,999 K with variable decimal position.
Offset	0.01 - 9,999.99 K.
Update time	One time per second.
Voltage drop	Max. 1V DC @ 20mA.
Note TA	External power to sensor is required; e.g. type PD.
Type TP	Range -100°C to +200°C (-148°F to 392°F).
Wires	2-, 3- or 4-wire PT100.
Update time	One time per second.
Accuracy	2-wire: +/- 0.1°C @ Ta 20°C + 0.008°/Ta °C. 3- or 4-wire: +/- 0.1°C @ Ta 20°C + 0.005°/Ta °C.

Signal inputs - Pressure

Type IA	(0)4 - 20mA. Analog input signal can be scaled to any desired range within 0 - 20mA.
Accuracy	15 bit. Error 0.01% @ 20°C (Typical 35ppm/°C).
Span	0.00000 / 999,999 K with variable decimal position.
Offset	0.01 - 9,999.99 K.
Update time	One time per second.
Voltage drop	Max. 1V DC @ 20mA.
Note IA	External power to sensor is required; e.g. type PD.

Signal outputs - Digital output

Function	<ul style="list-style-type: none"> Scaled pulse: Transmitting corrected acc total. Input pulse retransmission (squared, OT only).
Frequency	Max. 500Hz. Pulse length user definable between 1msec up to 10 seconds. Retransmission: Minimum pulse duration: 50µs, square wave output based on frequency of (sine wave or coil) input signal.
Type OR	One isolated electro-mechanical relay output (NO). Maximum resistive load: 1A @ 250V AC / 30V DC. Maximum inductive load: 0,5A (pilot duty applications). Type OT remains also available.
Restrictions OR	Requires 24 - 27V DC and supplied via P5 - P6. Frequency max. 0.5Hz.
Type OT	One passive transistor output (NPN) - not isolated. 300mA - 50V @ 25°C.

Signal outputs - Communication option

Function	Reading display info, clear total and read/write configuration settings.
Protocol	Modbus ASCII / RTU.
Type CB	RS232
Type CH	RS485 2-wire
Type CU	Local USB communication for connection to a PC / laptop incl. Ex d USB plug at the right-hand side entry.
Restriction CU	Requires 3/4"NPT or M25 side entry thread.
Type CX	No communication, remote configuration possible with accessory cable ACE02.

Signal outputs - Analog output

Function	Transmitting corrected flow rate.
Type AH	Galvanically isolated, loop powered 4 - 20mA output
Accuracy	12 bit. Error 0.03% @ 20°C (Typical 45ppm/°C). Output signal can be scaled to any desired range.

Flow equations

Type EG	Corrected gas volume.
Formula	$Q_{normal} = Q \times \left(\frac{P}{P_{ref}} \right) \times \left(\frac{T_{ref}}{T} \right) \times \left(\frac{C_{ref}}{C} \right)$

Operator functions

Displayed info	<ul style="list-style-type: none"> Compensated flow rate and / or total. Compensated total and accumulated total. Current day (daily) total and previous day The last 15 historical day totals are stored and can be displayed. Actual line temperature / pressure. Indicating speedometer for flow rate. Reset total by pressing the CLEAR-key twice.
-----------------------	---

Total

Digits	7 digits.
Units	L, m³, US gal, igan, cf, Oil bbl, kg, ton, US ton, lb or none.
Decimals	0 - 1 - 2 or 3.
Note	Total can be reset to zero.

Accumulated total

Digits	11 digits.
Units / decimals	According to selection for total.
Note	Can not be reset to zero.

Flow rate

Digits	7 digits.
Units	mL, L, m³, mg, g, kg, ton, US ton, US gal, igan, Oil bbl, lb, cf, rev, none, scf, nm³, nL or p.
Decimals	0 - 1 - 2 or 3.
Time units	/sec - /min - /hr - /day.

Line temperature / pressure

Digits	6 digits.
Units	Temperature: °C, °F or K Pressure: mbar, bar, PSI.
Decimals	1.

		Description
Model	E126-EG	Flowcomputer with temperature and pressure compensation for corrected gas volume.
Input	P	Pulse input: coil, npn, pnp, namur.
Analog output	AH	Galvan. isolated, loop powered 4-20mA output.
Communication	CB	RS232 communication - Modbus ASCII / RTU.
	CH	RS485 communication - 2wire - Modbus ASCII / RTU.
	CU	USB communication - requires. 3/4"NPT or M25 thread.
	CX	No communication, remote configuration is possible.
Equation	EG	Corrected gas volume.
Enclosures	HA_	Die-cast aluminum Ex d enclosure.
	HS_	Stainless steel 316L Ex d enclosure.
	H_A	Entry threads: 2 x 3/4"NPT / 1 x 1"NPT.
	H_B	Entry threads: 3 x 3/4"NPT.
	H_C	Entry threads: 2 x 1/2"NPT / 1 x 1"NPT.
	H_D	Entry threads: 2 x 1/2"NPT / 1 x 3/4"NPT.
	H_G	Entry threads: 2 x M20 / 1 x M25.
	H_H	Entry threads: 3 x M25.
Additional Input	IA	(0)4 - 20mA pressure input.
	IB	Remote control input to reset total or to lock the "clear total" button.
Digital output	OR	Mechanical relay output (OT remains available) - requires 24 - 27V DC.
	OT	Passive transistor output.
Power	PD	9 - 27V DC + sensor supply.
	PX	Basic power supply 9 - 27V DC (no real sensor supply).
Battery	PB	Additional lithium battery powered (optional).
Temp. input	TA	(0)4 - 20mA temperature input
	TP	PT100 temperature input.
Hazardous	XD	Explosion proof according ATEX, IECEx, FM and CSA c-us.
Options	ZB	Backlight is included as standard.
	ZF	Coil input 10mVpp.
	ZG	Coil input 5mVpp.

The **bold** marked text contains the standard configuration: E126-P-AH-CX-EG-HAA-IA-IB-OT-PX-TP-XD-ZB.